

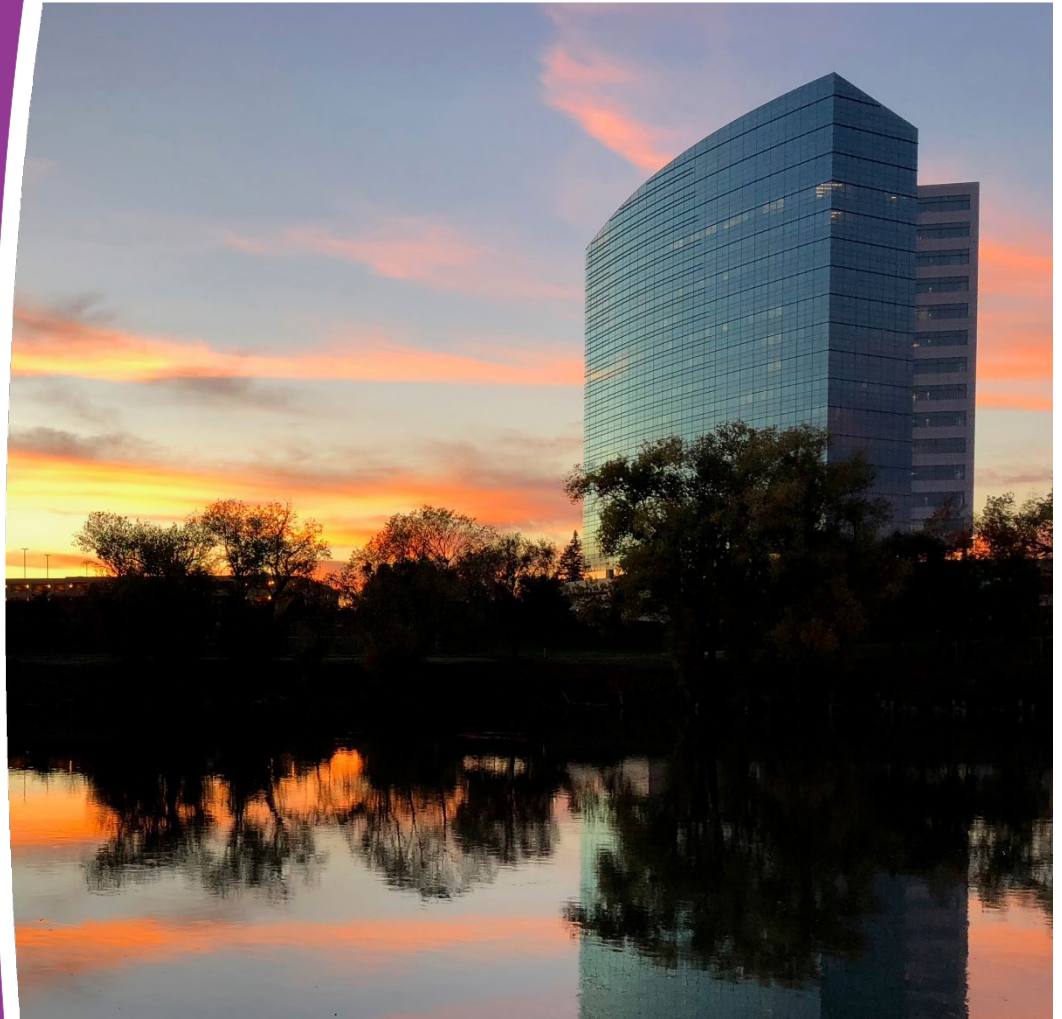

Enterprise Technology Projects

FISCAL YEAR

2021-22



SECOND QUARTER REPORT

Quarter Ending December 31, 2021

ENTERPRISE TECHNOLOGY PROJECTS

FISCAL YEAR 2021-22
SECOND QUARTER REPORT

At the end of the second quarter for fiscal year 2021-22, CalSTRS had eight enterprise projects: six major technology projects over \$1 million and two additional projects under \$1 million.

The Project Support Office monitors and reports monthly on the technology appropriations budget and enterprise projects' status to the Enterprise Program Investment Council and quarterly to the Teachers' Retirement Board.

ENTERPRISE PROGRAM INVESTMENT COUNCIL MEMBERS

Cassandra Lichnock
Chief Executive Officer

Lisa Blatnick
Chief Operating Officer

Julie Underwood
Chief Financial Officer

Melissa Norcia
Chief Administrative Officer

Teresa Schilling
Chief Public Affairs Officer













Ashish Jain
Chief Technology Officer

Bill Perez
Chief Benefits Officer

Scott Chan
Deputy Chief Investment Officer

MAJOR ENTERPRISE TECHNOLOGY PROJECTS

The following table summarizes current major enterprise technology projects during the second quarter.

Project Name	Project Duration	Schedule (Status)	Project Budget ¹	Budget Expended ²	Budget (Status)
BusinessDirect Retrofit	Jul 2018 – Jan 2022	 ³	\$9,769,238 ⁴	\$5,600,969	
Data Quality	Nov 2011 – Jun 2022		\$30,910,879	\$26,386,008	
Datacenter Hosting and Migration Services	Nov 2020 – Oct 2023		\$19,900,000	\$2,907,271	
HR Link	Dec 2018 – Jan 2022	 ⁵	\$2,469,315	\$694,181	
Pension Solution	Jul 2014 – Feb 2023	 ⁶	\$304,833,040	\$217,746,928	
Transformation Readiness	Jul 2016 – Jun 2022		\$18,356,368	\$14,871,630	

Schedule & Budget Indicators  *On Track*  *Warning*  *Critical*  *Complete*  *Cancelled*  *Not Started*

¹ Project Budget – Amount represents the sum of the projects' prior years' actual expended, remaining encumbrances, and current and future years budgeted amounts.

² Budget Expended – Amount represents the total expended.

³ BusinessDirect Retrofit – The schedule is dependent on the implementation schedule for the Pension Solution Project.

⁴ BusinessDirect Retrofit – In addition to the amount reported above, the Pension Solution Project is providing \$5.4 Million funding for system enhancements to pension administration-related functionality.

⁵ HR Link - A Change Request is in process to extend the project from January 31, 2022 through June 30, 2022 to accommodate an extension to Phase 1.

⁶ Pension Solution – The red indicator is due to the vendor experiencing significant delays with Contractor Acceptance Testing - Part B for Functional Rollout 2. CalSTRS is also experiencing a lower-than-expected pass rate in User Acceptance Testing. Additionally, the vendor is making slower progress in fixing the defects than anticipated. The delayed completion is impacting the project schedule and all downstream project activities including User Acceptance Testing and the Go-Live dates for both FR2 and FR3.

MAJOR ENTERPRISE TECHNOLOGY PROJECTS

BUSINESSDIRECT RETROFIT

The BusinessDirect Retrofit project goals and objectives are to support CalSTRS in the implementation of a new pension administration system, BenefitConnect. This will be accomplished by modifying BD to migrate specific pension functionality out of BD and into BC, building new interfaces between BD and BC, modifying some existing interfaces between BD and BC and external entities, and extracting/mapping historical data from BD to BC to support functionality migration.

NOTE: The schedule for this project is dependent on the Pension Solution Project schedule, for which, as noted in this report, a complete schedule and budget (including milestones, cost, and staffing) analysis is being conducted. For this reason, it is unknown at this time what major activities and milestones will be completed during this quarter. However, a Change Request is in circulation to extend project resources through Q3 to complete specific project milestones as noted below.

PROJECT BUDGET

\$9.8 Million

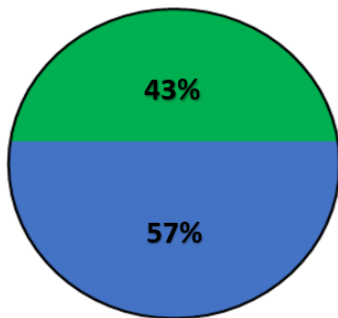

● % Expended ● % Remaining

ACCOMPLISHMENTS – PERIOD ENDING DECEMBER 31, 2021

- Passed 45% of test cases for User Acceptance Testing.
- Completed development of training materials and related traceability matrix (deliverable) for the Financial Services Branch.
- Completed BusinessDirect environment upgrades for UAT.

PLANNED MAJOR ACTIVITIES & MILESTONES BY MARCH 31, 2021

- Complete BusinessDirect environment upgrades for Parallel Test.
- Complete Parallel Test activities and related deliverables.
- Complete FR2 Integration Test activities and related deliverables.
- Complete Performance Test activities and related deliverables.

PROJECT SCHEDULE STATUS TIMELINE

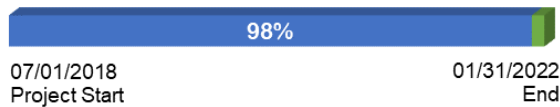

FISCAL YEAR 2021–22 MAJOR MILESTONES

Because the schedule for this project is dependent on the Pension Solution Project schedule, the expected milestone and completion dates are not fully known until the schedule for the Pension Solution Project has been reforecast.

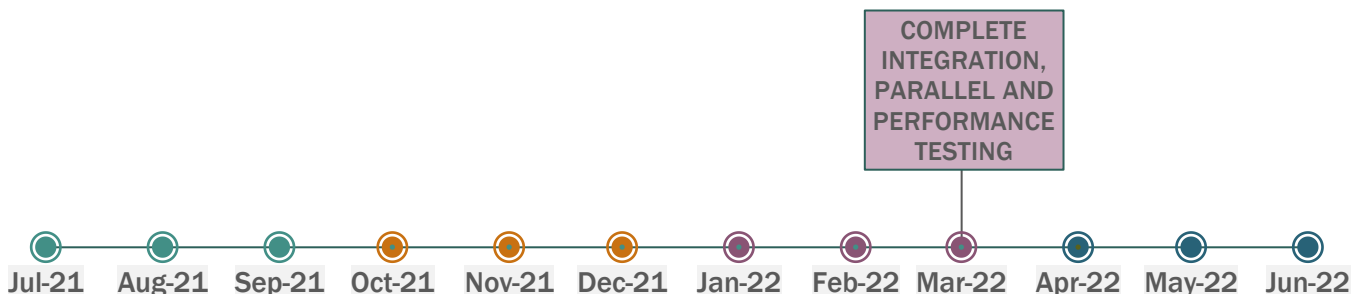

MAJOR ENTERPRISE TECHNOLOGY PROJECTS

DATA QUALITY

The Data Quality project is in the second phase of data cleansing to include data clean-up and preparation for conversion to the new pension administration system.

NOTE: The schedule for this project is dependent on the Pension Solution Project schedule, for which, as noted in this report, a complete schedule and budget (including milestones, cost, and staffing) analysis is being conducted. For this reason, the Planned Major Activities from the prior report were not accomplished but will be added back to the report after the new schedule is finalized.

PROJECT BUDGET

\$30.9 Million

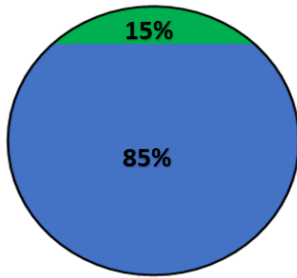

● % Expended ● % Remaining

ACCOMPLISHMENTS – PERIOD ENDING DECEMBER 31, 2021

- Completed testing for Archive Flag Rerun.
- Completed one Conversion Fallout Issue.

PLANNED MAJOR ACTIVITIES & MILESTONES BY MARCH 31, 2021

- Rerun Data Fix for Archive Flag.
- Rerun Data Fix for Member Lifecycle Fix A.
- Prepare remaining data fixes to rerun.

PROJECT SCHEDULE STATUS TIMELINE

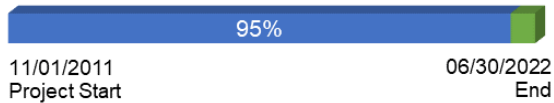

FISCAL YEAR 2021-22 MAJOR MILESTONES⁷

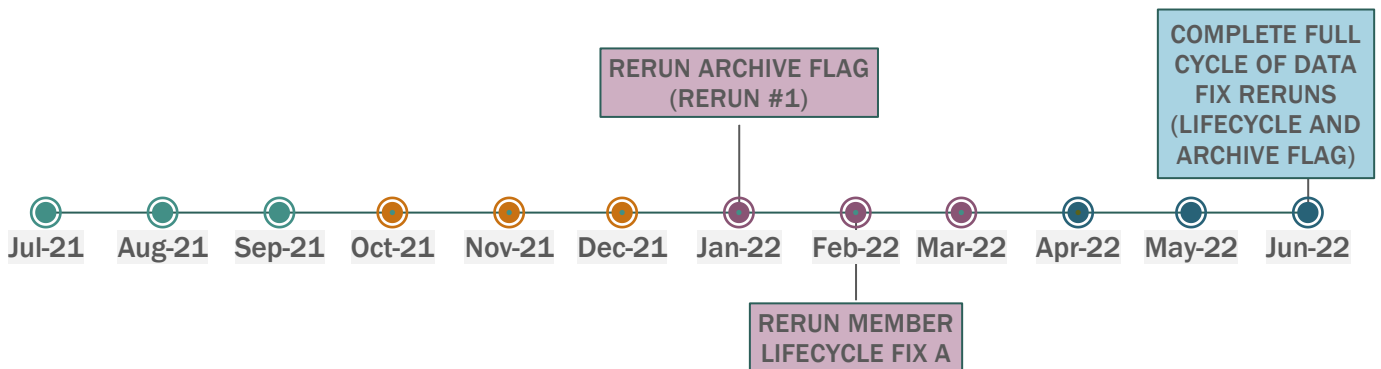

⁷ As approved by Pension Solution Steering Committee.

MAJOR ENTERPRISE TECHNOLOGY PROJECTS

DATACENTER HOSTING AND MIGRATION SERVICES

The Datacenter Hosting and Migration Services project will enable CalSTRS to mitigate the business continuity risks, supports CalSTRS enterprise strategic goals, and establishes a flexible framework for operational efficiency and cost optimization through the migration of on-premise critical systems/equipment onto a multi-modal data center solution.

PROJECT BUDGET

\$19.9 Million

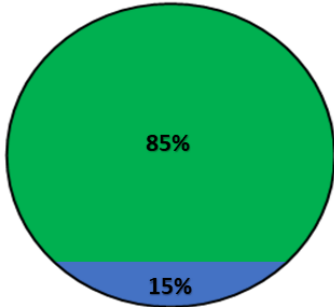

● % Expended ● % Remaining

ACCOMPLISHMENTS – PERIOD ENDING DECEMBER 31, 2021

- Completed the re-baseline of the DHMS Project Schedule.
- Completed the designs for remote access solutions.
- Migrated the production environments for 403b Compare and Online Forms to AWS.

PLANNED MAJOR ACTIVITIES & MILESTONES BY MARCH 31, 2021

- Complete the migration of the Electronic Content Management System and related Connectors, BusinessDirect and related Connectors, Investment CPEs, and Contact Center solutions.
- Start the user pilots for the AppGate ZTNA & VMware Horizon/VDI remote access solutions.

PROJECT SCHEDULE STATUS TIMELINE



FISCAL YEAR 2021–22 MAJOR MILESTONES

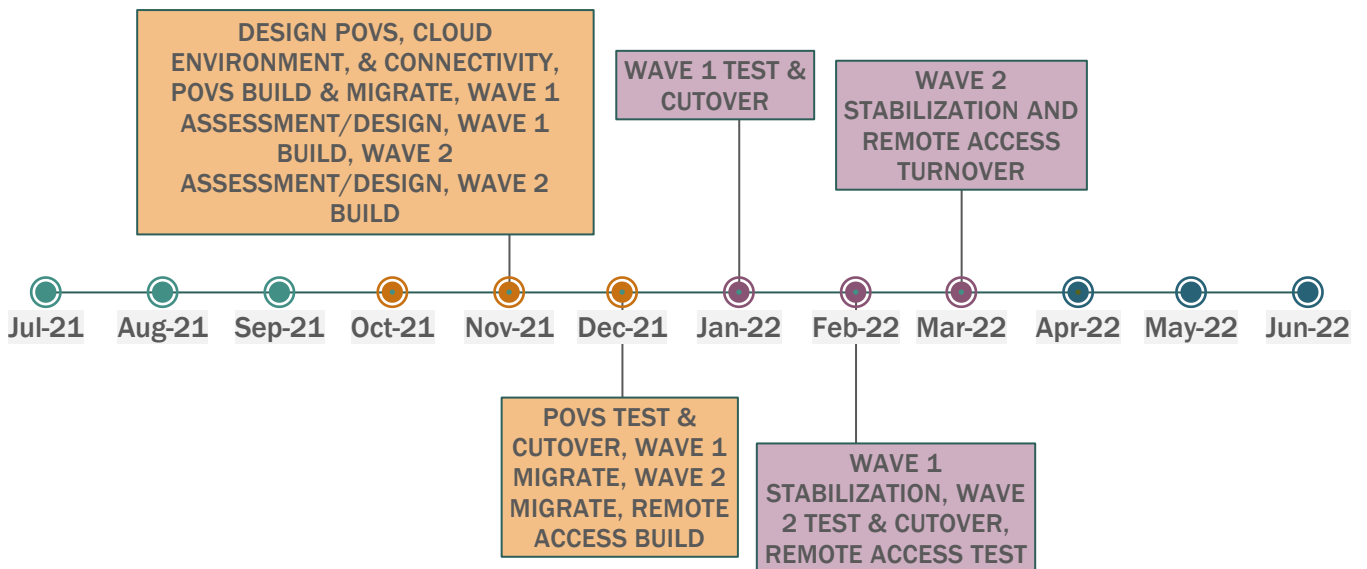

MAJOR ENTERPRISE TECHNOLOGY PROJECTS

HR LINK

The HR Link project will improve efficiencies by automating Human Resource processes, delivering real-time data and a self-service platform for all CalSTRS staff. The solution includes a core HR platform and tools for time management, learning and development, performance and goals, succession planning, onboarding, workforce planning and analytics. This is a multi-year project that will be implemented in phases. Employee Central and Learning and Development are the first modules and include a core HR platform, time and attendance management, and a learning management system.

NOTE: A Change Request is in process to extend the project from January 31, 2022 through June 30, 2022 to accommodate an extension to Phase 1. A separate change request will be presented to formally remove time management from scope, as well as update schedule and resources to accommodate Phase 2. The content in the Major Milestones graph below reflects the Phase 1 milestones expected to be approved through the requested extension date of June 30, 2022.

PROJECT BUDGET

\$1.5 Million

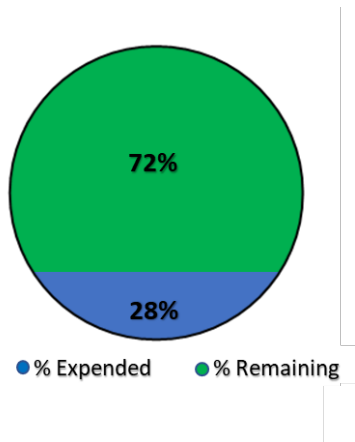

ACCOMPLISHMENTS – PERIOD ENDING DECEMBER 31, 2021

- Change Request to extend Phase 1 through January 31, 2022, extend Phase 1 resources and create Phase 2 resources, purchase Phase 2 licenses, and create contract contingency was approved. Subsequent contract amendment was executed.
- Made Project Decision to remove Time and Attendance from scope.

PLANNED MAJOR ACTIVITIES & MILESTONES BY MARCH 31, 2021

- Complete regression testing.
- Sign off on CalSTRS Testing
- Begin cutover activity for Phase 1 modules
- Begin HR Link training.
- Complete change request to extend Phase 1 through June 30, 2022.

PROJECT SCHEDULE STATUS TIMELINE

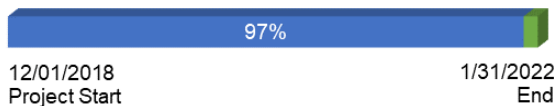

FISCAL YEAR 2021-22 MAJOR MILESTONES

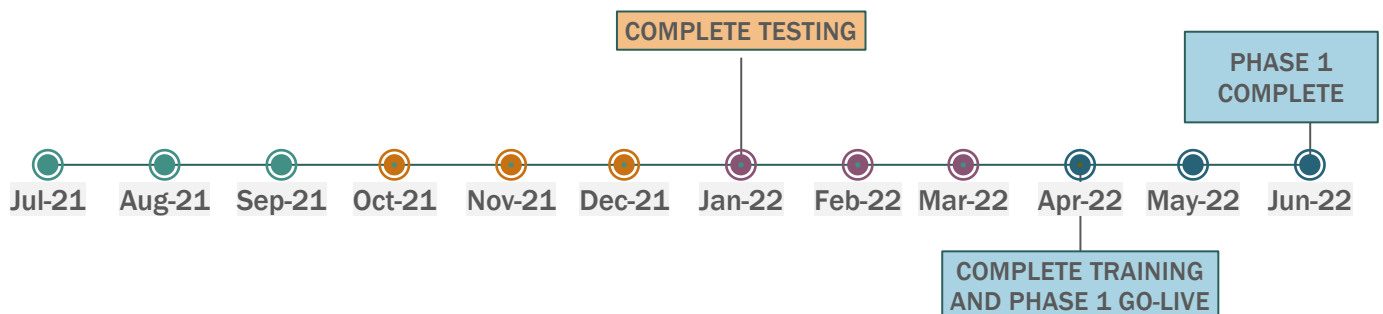

MAJOR ENTERPRISE TECHNOLOGY PROJECTS

PENSION SOLUTION

The Pension Solution Project will replace the CalSTRS legacy pension administration system to increase the organization's ability to respond to business and customer needs; enhance services to members, beneficiaries, staff and employers; gain long-term operational efficiencies; and improve internal controls.

NOTE: A complete analysis is being conducted for the schedule and budget (including milestones, cost, and staffing) for the project. A Change Request is expected to be submitted once the analysis is complete. Once the CR is approved, the timelines below will be updated.

PROJECT BUDGET

\$304.8 Million

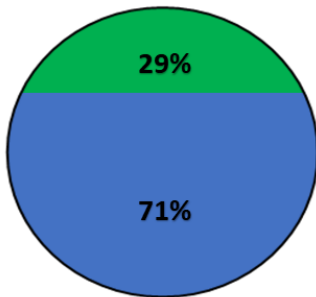

● % Expended ● % Remaining

ACCOMPLISHMENTS – PERIOD ENDING DECEMBER 31, 2021

- Passed 3,028 of 3,919 executed test runs for Functional Rollout 2 User Acceptance Testing.

PLANNED MAJOR ACTIVITIES & MILESTONES BY MARCH 31, 2021

- Complete Contractor Acceptance Testing (Part-B) for Functional Rollout 2.
- Provide details of the schedule replanning effort and adjustments to the remaining project tasks and milestones.

PROJECT SCHEDULE STATUS TIMELINE⁸

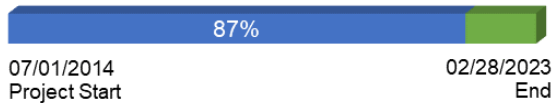

FISCAL YEAR 2021-22 MAJOR MILESTONES

NOTES: Milestones will be added after the schedule replanning efforts are finalized.

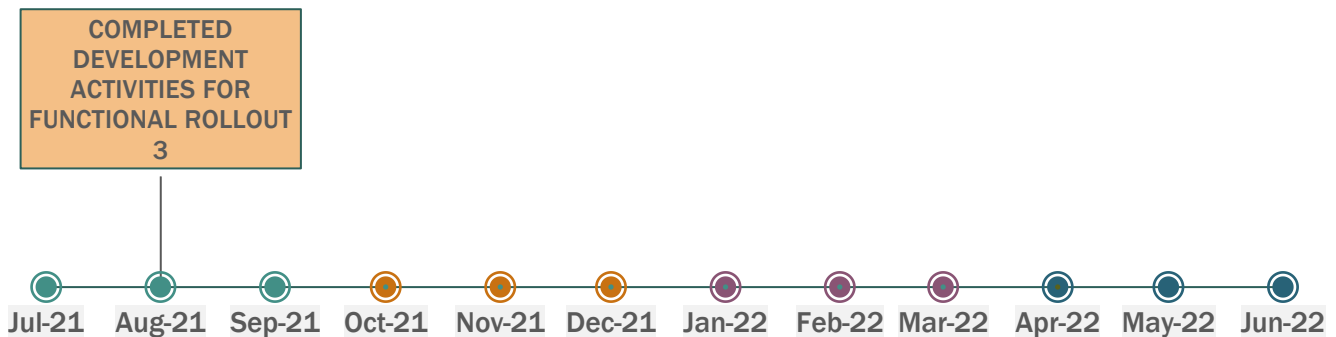

⁸ CalSTRS does not anticipate meeting this project completion date. A revised date is being determined.

MAJOR ENTERPRISE TECHNOLOGY PROJECTS

TRANSFORMATION READINESS

The Transformation Readiness project supports business areas and prepares staff for impacts, changes, and benefits from large enterprise modernization efforts.

PROJECT BUDGET

\$18.3 Million

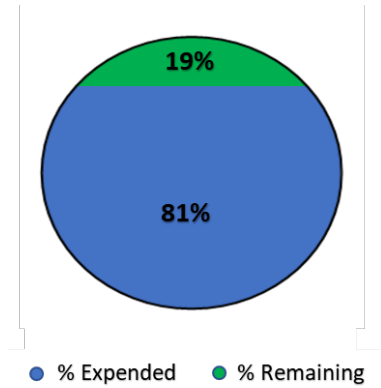

ACCOMPLISHMENTS – PERIOD ENDING DECEMBER 31, 2021

- Completed Functional Rollout 2 training material development with open items dependent on future schedule and vendor resources.
- Completed Functional Rollout 2 computer-based training revisions.
- Completed Functional Rollout 3 initial training content analysis.
- Completed onboarding for new change champions.
- Launched collaboration site for change champions.
- Published video viewer guides of Functional Rollout 3 system demonstrations and made viewer guides and video content available through the change management site.

PLANNED MAJOR ACTIVITIES & MILESTONES BY MARCH 31, 2021

- Conduct awareness activities to increase organizational awareness of project.
- Deliver Functional Rollout 3 training analysis for business area review.
- Deliver Change Leadership Toolkit to change champions and change leaders.
- Deliver Discussion Starter to leaders to help address change fatigue.
- Develop an MS Teams channel for change champions to enhance collaboration.
- Finalize Pension Solution overview materials shared at new employee onboarding.
- Finalize Transformation Readiness Schedule in support of Pension Solution Project.

PROJECT SCHEDULE STATUS TIMELINE

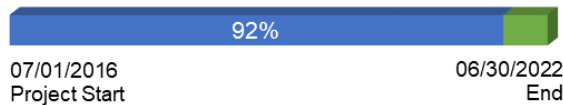





FISCAL YEAR 2021-22 MAJOR MILESTONES

Because the schedule for this project is dependent on the Pension Solution Project schedule, the expected milestone dates are unknown until the schedule for the Pension Solution Project has been reforecast.



OTHER ENTERPRISE PROJECTS UNDER \$1 MILLION

The following table summarizes other reportable enterprise projects under \$1 million during the second quarter.

Project and Description	Project Duration	Schedule (Status)	Project Budget ⁹	Budget Expended ¹⁰	Budget (Status)
CalSTRS.com Modernization Provides CalSTRS with a modern public-facing website that meets the latest web architecture standards and caters to members, investors, and all other CalSTRS business partners' needs.	Sep 2020 – Apr 2022		\$678,123	\$221,203	
Print to Mail Software Install and integrate Pitney Bowes print-to-mail software, Planet Press, between the new pension administration system and our centralized printer. Provides the ability to process outgoing member correspondence in zip code order and varying page-counts, to align with how it is generated by BenefitConnect. Provides a modern print-to-mail software solution with more automated workflow and built-in security oversight protections and risk-mitigation measures.	Dec 2020 – Oct 2021	 ¹¹	\$559,283	\$8,774	

Schedule & Budget Indicators  On Track  Warning  Critical  Complete  Cancelled  Not Started

⁹ Project Budget – Amount represents the sum of the projects' prior years' actual expended, remaining encumbrances, and current and future years budgeted amounts.

¹⁰ Budget Expended – Amount represents the total expended.

¹¹ Print to Mail Software Schedule – The schedule is dependent on the implementation schedule for the Pension Solution Project.

